

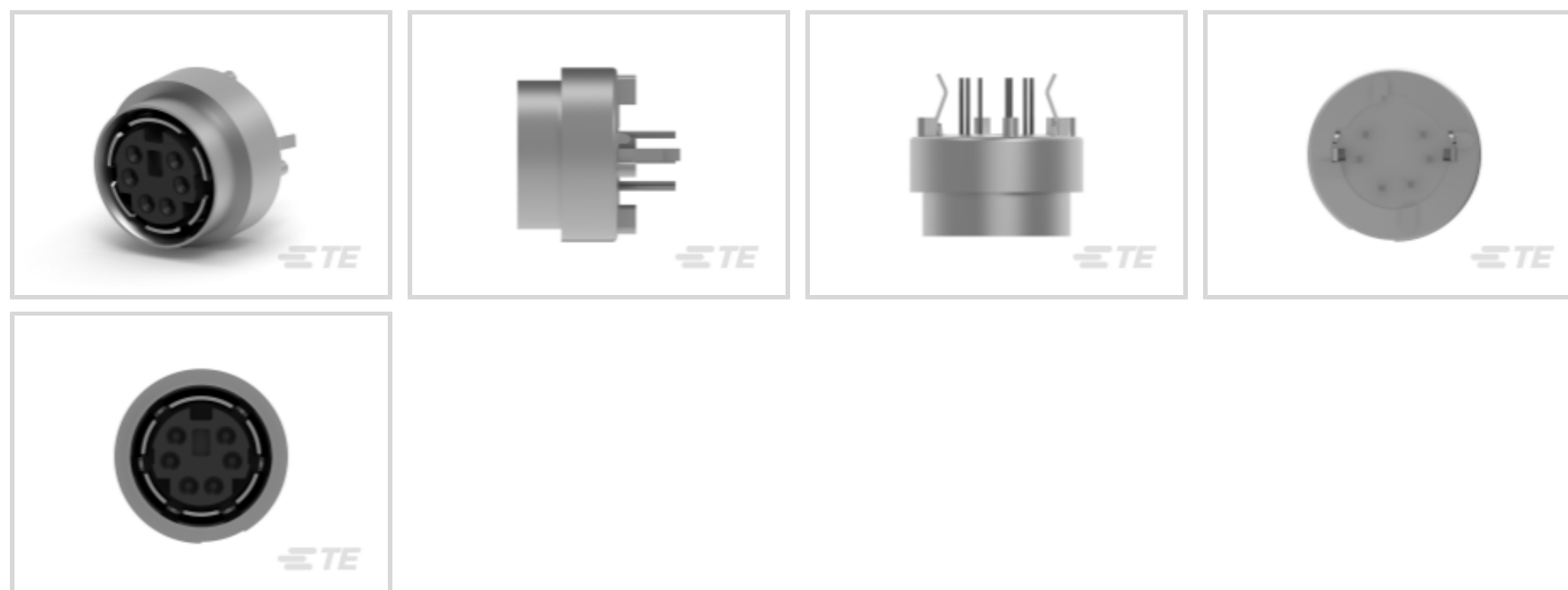

Connectors > Circular Connectors > DIN Connectors



Circular DIN Connector Type: **Mini DIN**

Connector & Housing Type: **Receptacle**

Connector System: **Wire-to-Board**

Number of Positions: **6**

Connector Contact Load Condition: **Fully Loaded**

Features

Product Type Features

ESD Protection	Without
Circular DIN Connector Type	Mini DIN
Connector & Housing Type	Receptacle
Connector System	Wire-to-Board
Sealable	No
Connector & Contact Terminates To	Printed Circuit Board
Shielded	No
Connector Type	Header
Shape	Circular
Product Type	Connector

Configuration Features

Stacked	No
Number of Positions	6
Connector Contact Load Condition	Fully Loaded
PCB Mount Orientation	Vertical

Electrical Characteristics

Operating Voltage	30 VAC
-------------------	--------

Body Features

Outer Shield Material	Copper Alloy
Panel Grounding	Without
Shield Underplate Material	Nickel
Panel Ground Feature Type	None
Inner Shield Plating Material	Tin-Lead over Nickel
Inner Shield Material	Brass
Outer Shield Plating Material	Tin-Lead over Copper
Front Panel Screw-Down	Without
Shield Plating Finish	Bright
Shield Underplate Thickness	1.27 μm [50 μin]
Shield Material	Brass

Contact Features

Contact Layout	Staggered
PCB Termination Area Plating Finish	Matte
Contact Underplating Material Thickness	1.27 μm [50 μin]
Contact Underplating Material	Nickel
PCB Contact Termination Area Plating Material	Tin-Lead
Contact Base Material	Phosphor Bronze
Contact Current Rating (Max)	.5 A
Contact Design	Tuning Fork
Contact Type	Socket
Contact Termination Area Plating Thickness	2.54 μm , 3.81 μm [100 μin][150 μin]
Contact Transmits (Typical)	Signal (Data)
Contact Mating Area Plating Thickness	.76 μm [30 μin]
Contact Mating Area Plating Material	Gold

Termination Features

Grounding Clips	Without
Termination Method to Printed Circuit Board	Through Hole - Solder

Mechanical Attachment

PCB Mount Alignment Type	Hold-Down
--------------------------	-----------

PCB Mount Alignment	With
Panel Mount Feature	With
Panel Mount Feature Type	Screw Nut
Mating Alignment	With
Mating Alignment Type	Polarization
PCB Mount Retention	With
PCB Mount Retention Type	Kinked Legs
Connector Mounting Type	Board Mount

Housing Features

Centerline (Pitch)	6.5 mm[.26 in]
Housing Color	Black
Housing Material	Polyester

Dimensions

Width	13.97 mm[.55 in]
PCB Tail Length	3.18 mm[.125 in]
Length	13.97 mm[.55 in]
Tail Length	3.18 mm[.125 in]
PCB Thickness (Recommended)	2.68 mm[.11 in]
Height	9.52 mm[.37 in]

Usage Conditions

Temperature Rating	High
Operating Temperature Range	-55 – 105 °C[-67 – 221 °F]

Operation/Application

Circuit Application	Signal
---------------------	--------

Industry Standards

UL Rating	Recognized
VDE Tested	No
Agency/Standard	CSA, UL
UL File Number	E28476
UL Flammability Rating	UL 94V-0

Packaging Features

Packaging Quantity	38
--------------------	----

Packaging Method

Tube

Product Compliance

[For compliance documentation, visit the product page on TE.com>](#)

EU RoHS Directive 2011/65/EU

Not Compliant

EU ELV Directive 2000/53/EC

Not Compliant

China RoHS 2 Directive MIIT Order No 32, 2016

Restricted Materials Above Threshold

EU REACH Regulation (EC) No. 1907/2006

Current ECHA Candidate List: JUNE 2022 (224)
 Candidate List Declared Against: JAN 2018 (181)
 Does not contain REACH SVHC

Halogen Content

Low Halogen - Br, Cl, F, I < 900 ppm per homogenous material. Also BFR/CFR/PVC Free

Solder Process Capability

Wave solder capable to 265°C

Product Compliance Disclaimer

This information is provided based on reasonable inquiry of our suppliers and represents our current actual knowledge based on the information they provided. This information is subject to change. The part numbers that TE has identified as EU RoHS compliant have a maximum concentration of 0.1% by weight in homogenous materials for lead, hexavalent chromium, mercury, PBB, PBDE, DBP, BBP, DEHP, DIBP, and 0.01% for cadmium, or qualify for an exemption to these limits as defined in the Annexes of Directive 2011/65/EU (RoHS2). Finished electrical and electronic equipment products will be CE marked as required by Directive 2011/65/EU. Components may not be CE marked. Additionally, the part numbers that TE has identified as EU ELV compliant have a maximum concentration of 0.1% by weight in homogenous materials for lead, hexavalent chromium, and mercury, and 0.01% for cadmium, or qualify for an exemption to these limits as defined in the Annexes of Directive 2000/53/EC (ELV). Regarding the REACH Regulation, the information TE provides on SVHC in articles for this part number is based on the latest European Chemicals Agency (ECHA) 'Guidance on requirements for substances in articles' posted at this URL: <https://echa.europa.eu/guidance-documents/guidance-on-reach>

Documents

CAD Files

3D PDF

3D

Customer View Model

[ENG_CVM_CVM_750327-2_B_c-750327-2-b.2d_dxf.zip](#)

English

Customer View Model

[ENG_CVM_CVM_750327-2_B_c-750327-2-b.3d_igs.zip](#)

English

Customer View Model

[ENG_CVM_CVM_750327-2_B_c-750327-2-b.3d_stp.zip](#)

English



By downloading the CAD file I accept and agree to the [Terms and Conditions](#) of use.

[Product Specifications](#)

[Application Specification](#)

English